



New Horizons RP model instructions



- Build your own New Horizons spacecraft model using your 3D printer
- Files are available with the body whole or split vertically. Use the files based on your experience with your printer that are most likely to give you good results.
- What you'll need:
 - SC body or body halves from your printer
 - SC antenna from your printer
 - SC RTG from your printer
 - 1/4" dowels (available at any hardware store)
 - Adhesive for bonding parts together. (select an adhesive based on the media you are using in your 3D printer.)



New Horizons 4 piece assembly instructions

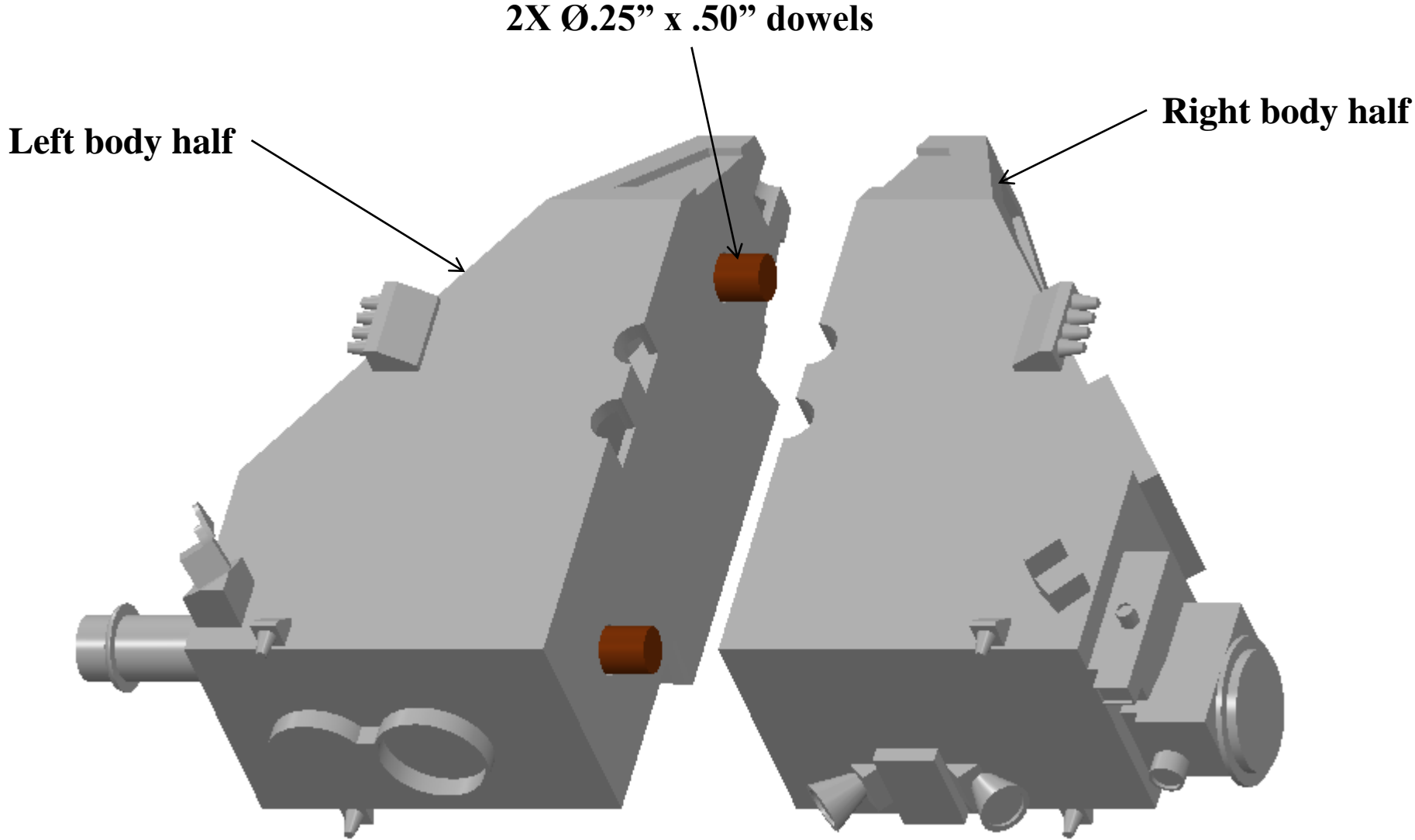



New Horizons 4 piece assembly instructions

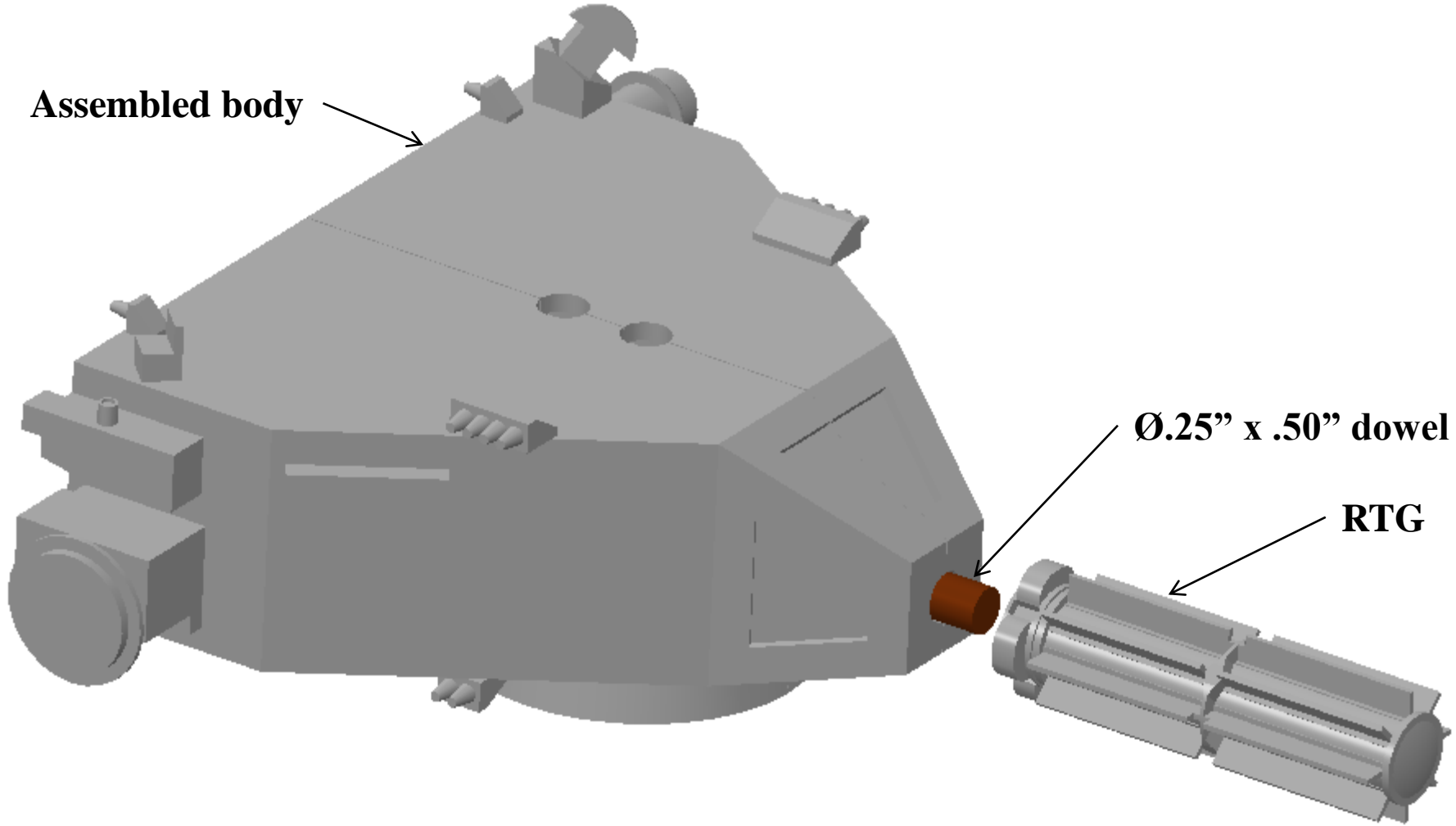

Assembled body

Ø.25" x .50" dowel

RTG



New Horizons 4 piece assembly instructions

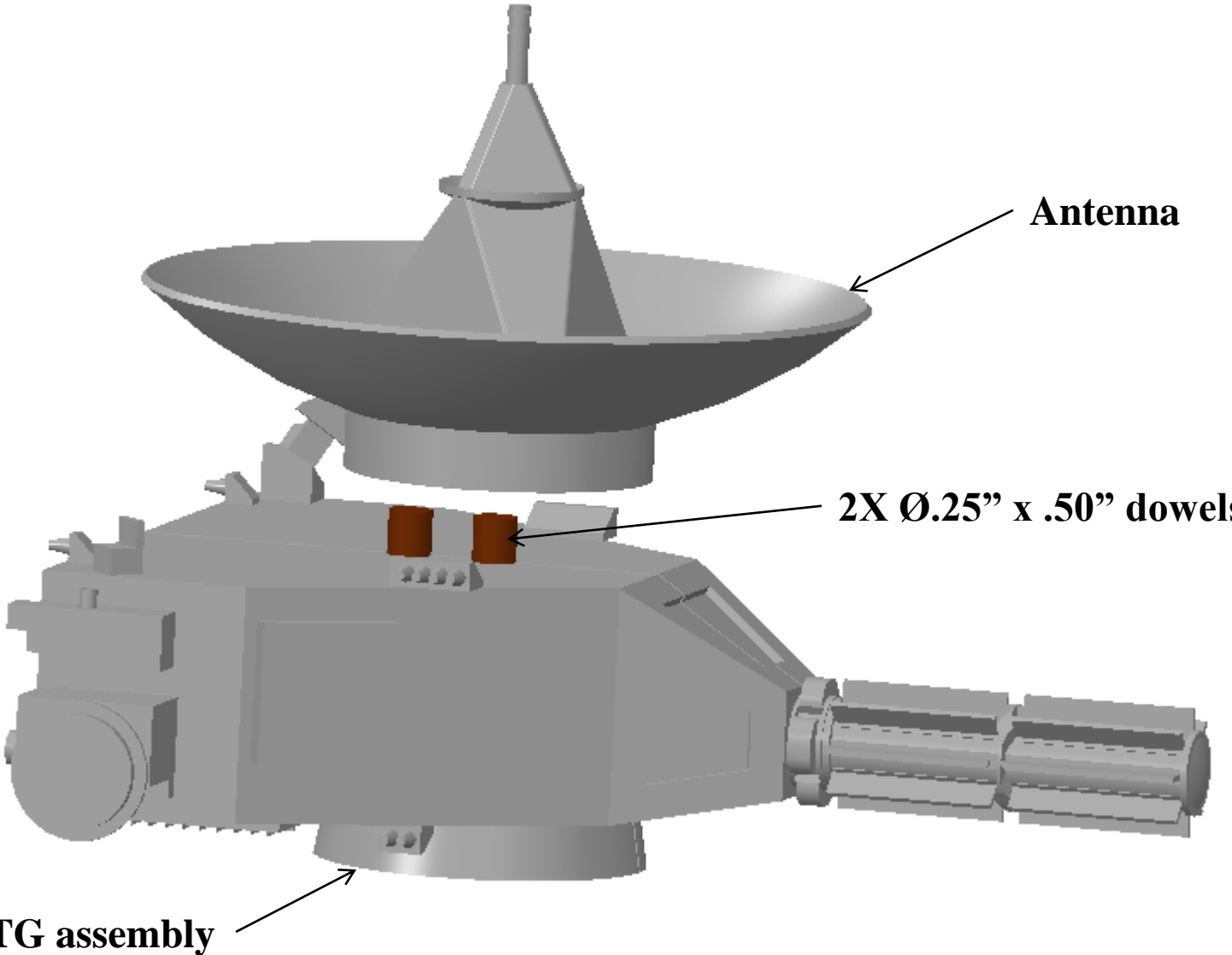

Body & RTG assembly



New Horizons 3 piece assembly instructions



Body

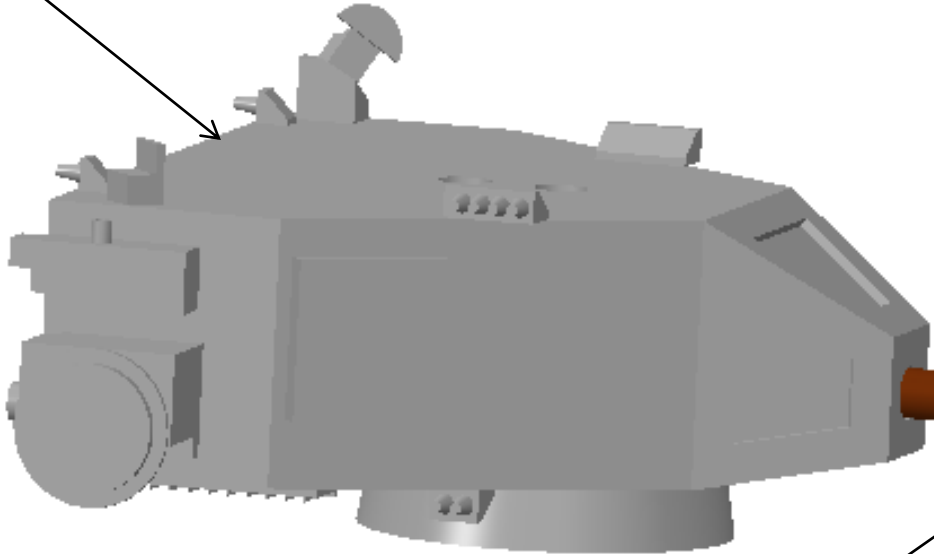
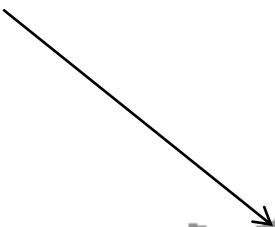

Ø.25" x .50" dowel

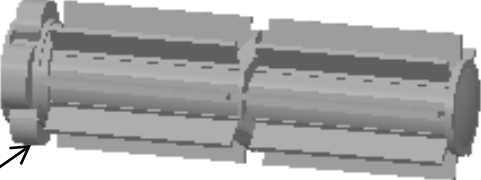

RTG

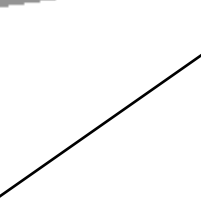



New Horizons 3 piece assembly instructions

